

PLAN

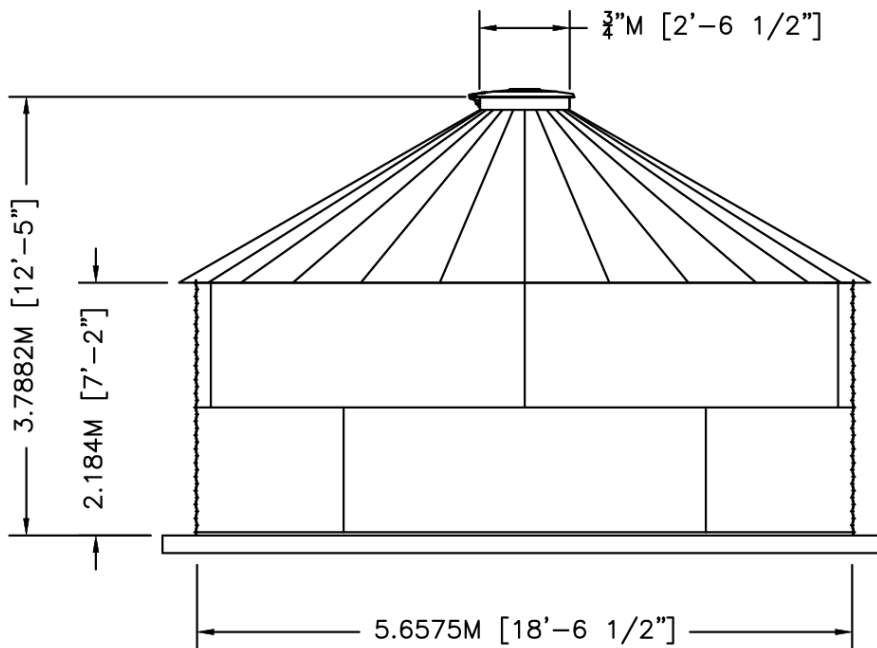

ELEVATION



	BY	DATE	TITLE	
DWN	XXX	XX/XX/XX	WTU06-02 30"PR 30DEG V-RIB	
CKD			NOMINAL CAPACITY - 51.720 M3 [13,663 GAL]	
ENG			DWG. NO. SCT1802-VR WTU06-02	REV. NO.
SIZE: A		SCALE: 3/16"=1'-0"		SHEET 1 OF 1